

HSF RoHS

SPECIFICATIONS
PERFORMANCE

Electical Rating: AC/DC 50V 0.5A
 Insulation Resistance: 500MΩ
 Withstang Volt: 200V AC/minute
 Opratng Temperature: -40°C to +105°C
 Material
 Contact: Phosphor Bronze
 Plating: Au or Sn Over Ni
 Housing: LCP
 Max.Processing Temp: 260°C±5° 5S

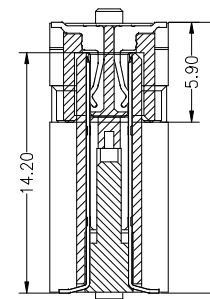
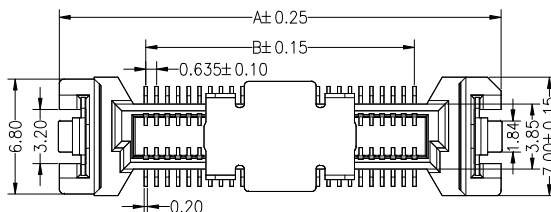

MATING DRAWING (REF)

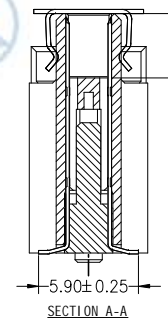
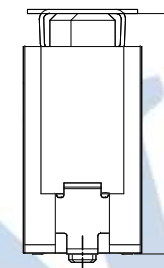
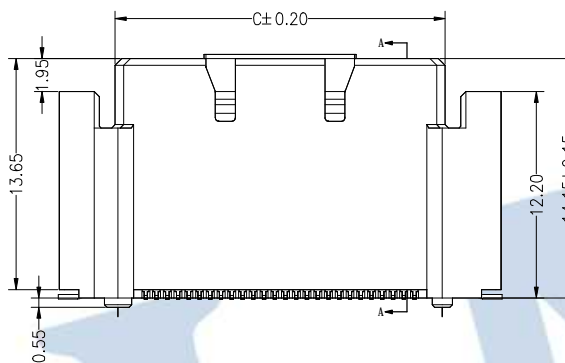

SECTION A-A

Ordering Information

3722 F XXX 142 XX X X 0X

F=Female
M=Male
No.of pins
30,40,
50,52P
Plastic Hight
142=14.2mm
Contact Plating
G0:Gold Flash
G1:3U" Gold
G2:5U" Gold
G3:10U" Gold
G4:15U" Gold
S0:1.5U" Gold/Tin
S1:3U" Gold/Tin
Insulator
Material
Option
D=BK-PA46
E=BK-PA9T
F=BK-LCP
Packing
T:Tube
R:Reel

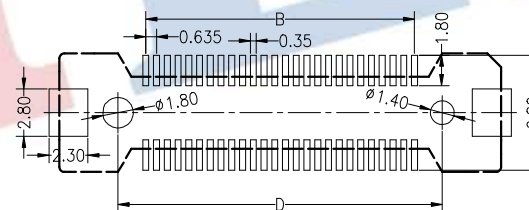
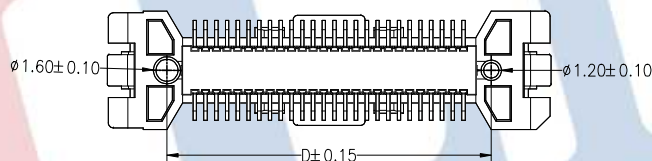

P.C.B Layout

No Of Pins	Dimensions (mm)			
	A	B	C	D
30	19.12	8.89	12.52	12.18
40	22.29	12.07	15.69	15.35
50	25.47	15.24	18.87	18.53
52	26.10	15.88	19.50	19.16

OPERATION		DRAW	Jelly Feng	2022.12.17	SCALE	FIT
X.X	±0.30				CHECK	
X.XX	±0.20	SIZE	A4			
X.XXX	±0.10	SHEET	1/1			
Angle	±3°	APPROVE			PROJ.	
DIM	TOL				TITLE:	0.635mm BTB NPin H14.2 Female (PLC专用)

JILN 深圳市锦凌电子有限公司
 SHENZHEN JINLING ELECTRONICS CO.,LTD
 Tel: 86-755-2997-5806/5802 Fax: 86-755-2997-5992

REV	DATE	MODIFICATION DESCRIPTION	CHANGE
A0	2022.12.17	NEW DRAWING	

1 2 3 4 5 6 7 8 9